

REMEX

TECHNICAL MANUAL

TAPE READER

MODELS RR-1002BB/LB/RB

REFER TO ADDENDUM SHEET



REMEX

TECHNICAL MANUAL

TAPE READER

MODELS RR-1002BB/LB/RB

MODEL RR-1002RB/115/S75

SERIAL 11828

MODE 115

***REMEX Electronics***

A UNIT OF EX-CELL-O CORPORATION  
5250 W. El Segundo Blvd.  
Hawthorne, California 90250

Copyright © 1966 by REMEX Electronics, a unit of  
Ex-Cell-O Corporation. Printed in the United States  
of America. All rights reserved. This book or parts  
thereof may not be reproduced in any form without  
permission of publishers.

## TABLE OF CONTENTS

1.	General Description .....	1
1.1	Equipment Description .....	1
1.2	Equipment Supplied .....	1
1.3	Specifications .....	3
1.4	List of Fuses and Semiconductors .....	5
1.5	Options .....	5
1.6	Mode and Module Descriptions .....	6
1.7	Tape Channel Numbering .....	6
2.	Installation .....	9
2.1	Unpacking .....	9
2.2	Power and System Connections .....	9
2.3	Reader Mounting .....	9
3.	Operation .....	10
3.1	Warm Up .....	10
3.2	Motor Speed Control .....	10
3.3	Operating Instructions .....	10
3.4	Operational Maintenance .....	11
4.	Theory of Operation .....	12
4.1	Reader Operational Descriptions .....	12
4.1.1	Transport Control Circuits .....	12
4.1.2	Perforation Sensing and Gated Output Circuits .....	13
4.1.3	Lamp and Power Supplies .....	14
4.2	Ungated Output Option .....	15
5.	Maintenance .....	16
5.1	Preventative Maintenance .....	16
5.2	Adjustments and Calibrations .....	18
5.2.1	Drive System Adjustment .....	18
5.2.2	Brake Magnet Cleaning Procedure .....	18
5.2.3	Lamp Focusing .....	20
5.2.4	Lamp Voltage Adjustment .....	21
5.2.5	Symmetry Adjustment, Gated Outputs .....	21
5.2.6	Symmetry Adjustment, Ungated Outputs .....	21
5.2.7	Alignment Procedure, Gated Outputs .....	22
5.2.8	Alignment Procedure, Ungated Outputs .....	23
5.3	Tape Splicing Instructions .....	24
5.4	Determination of Per Cent Light Transmissivity of a Tape .....	24
5.5	Gating and Ungating the Outputs .....	25
5.6	Disassembly and Reassembly Procedures .....	26
5.6.1	Lamp Replacement .....	26
5.6.2	Readout Assembly (Photocells) Replacement .....	26A
5.6.3	Module Replacement .....	26A
5.6.4	Brake Replacement .....	26A
5.6.5	Drive Magnet Replacement .....	26A
5.6.6	Capstan Replacement .....	26B
5.6.7	Transformer Replacement .....	26B
5.6.8	Motor Replacement .....	26B
5.6.9	Drive Belt Replacement .....	26C

TABLE OF CONTENTS, continued:

5.7	Typical Transistor Voltage Measurements .....	26D
5.8	Trouble Shooting Chart .....	26E
6.	Parts List .....	
6.1	Electronic Parts List .....	27
6.2	Mechanical Parts List .....	27
6.3	Parts List, Ungated Option .....	29
		31
7.	Drawings and Part Location Illustrations .....	
7.1	Scope .....	32
		32

## SECTION 1

### GENERAL DESCRIPTION

#### 1.1 Equipment Description

The REMEX Photo-cell Tape Reader, Model RR-1002BB, RR-1002RB or RR-1002LB is designed to meet the requirements of systems using 5, 7 or 8 channel punched tape as an input medium. Refer to Figure 1-1. Reliable, conservatively designed electronic circuits and rugged precision mechanical construction permit reliable, error-free reading of punched tape. Among their many and varied applications include digital computers, communication systems, numerical controls, systems checkout, and many other types of data processing equipment.

Conversion of information, from the form of perforations on the tape into electronic signals, is the function of the tape reader. As the tape passes under the reading lamp, the holes are recognized by means of photoelectric cells. Each cell output is then amplified and brought to the output receptacle for external routing and use.

External signals are used to control the movements of the tape. Model RR-1002BB is bidirectional, permitting either right or left movement of the tape, while Model RR-1002LB drives tape only to the left and Model RR-1002RB drives tape only to the right. Plug in modules give the reader versatility in being able to adapt the type of logic and voltage levels dictated by the specified input signals. Numerous combinations of input control and output signals are available from which the customer selects the set applicable to his requirements. Refer to Section 1.6.

#### 1.2 Equipment Supplied

Various items have been included with the reader for spare parts, installation and maintenance. These items are listed in Table 1-1.

<u>Item</u>	<u>Quantity</u>
Fuse, 2 amp, Slow Blow (Spare)	1
Fuse, KAA-2 (Spare)	1
Fuse, 1/2 amp (Spare)	1
Connector Plug, P1, Cannon, RSK-19-22C-1/2	1
Connector Plug, P2, Cannon, RSK-19-22C-1/2W	1
Silver Bearing Solder	1
Bristle Brush	1
Manual	1

Table 1-1. A list of items included with REMEX Tape Reader.

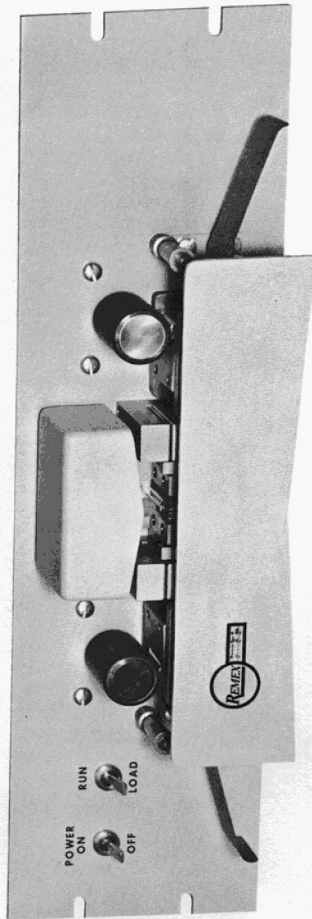

Figure 1-1. The REMEX Tape Reader, Model RR-1002BB.

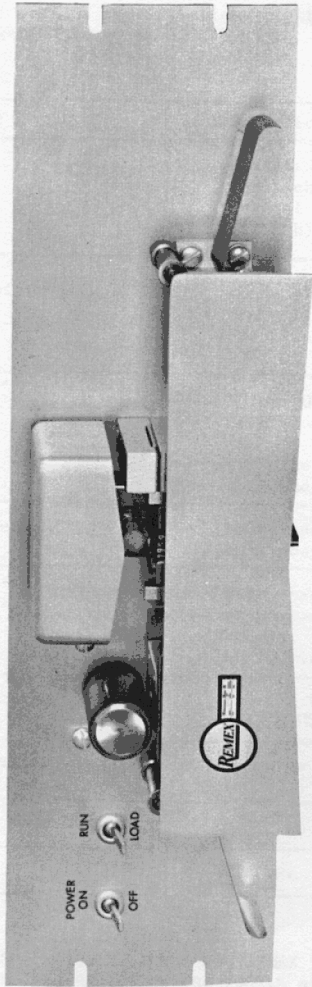

Figure 1-1A. The REMEX Tape Reader, Model RR-1002LB.



### 1.3 Specifications

Listed in Table 1-2 are the specifications of the REMEX Tape Reader, Models RR-1002EB, RR-1002LB and RR-1002RB.

Characteristic	Specification
Tape Width	Standard tape guide is adjustable for 5 channel (11/16 inch), 7 channel (7/8 inch) or 8 channel (1 inch) tape. Refer to Section 1.7.
Tape Transmissivity	Reads all tapes made of material where light transmissivity does not exceed 50%. Refer to Section 5.4.
Reading Speed	50 or 100 inches/second, continuous feed mode. Two speed standard.  20 inches/second, line-at-a-time step mode.
Tape Start Time	Less than 3 milliseconds from rest position.
Tape Stop Time	Less than 0.5 milliseconds. Stops on commanded character at 50 inches second. Stops before next character at 100 inches/second.
Power Requirements	100-130 VAC, 1.3 amps nominal, 60 cps, $\pm 3\%$ , single phase.
Ambient Temperature	Operates normally from 20 <sup>o</sup> F to 120 <sup>o</sup> F.
Size	Refer to Figure 1-2.
Weight	32 lbs.

Table 1-2. Specifications for the REMEX Tape Readers, Models RR-1002EB, RR-1002LB and RR-1002RB.

TEST JACKS & FUSES

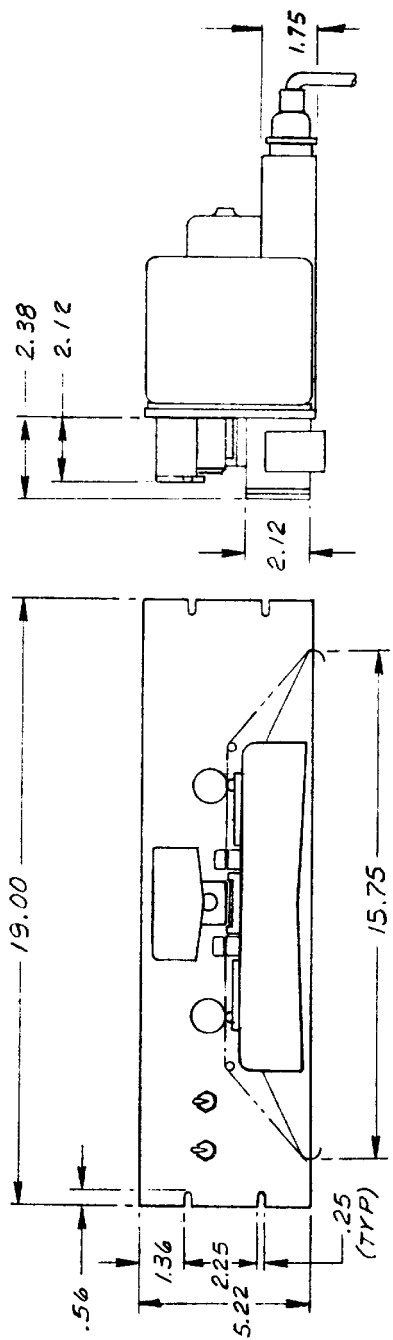
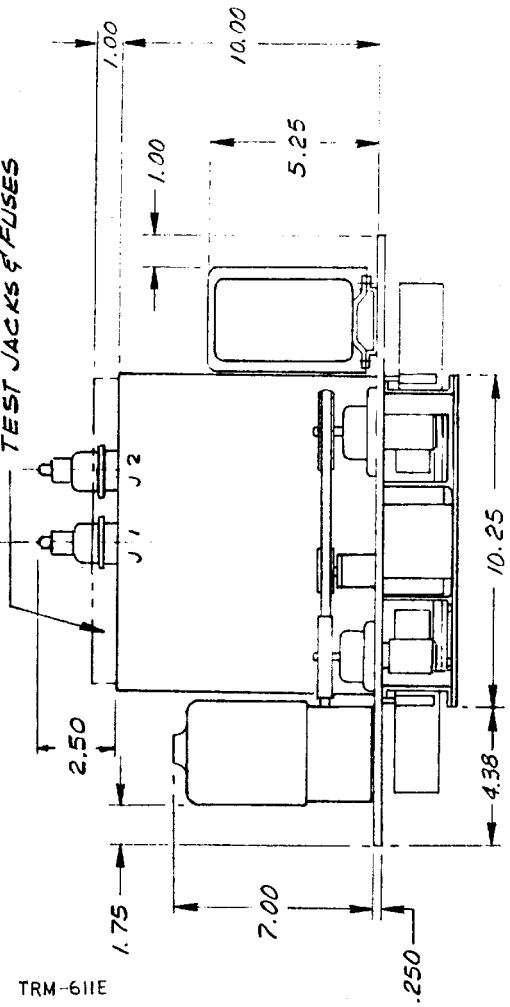

FIGURE 1-2  
RR1002BB INSTALLATION DRAWING 102895 B

#### 1.4 List of Fuses and Semiconductors

All fuses and Semiconductors which are used in the reader are listed in Table 1-3.

<u>COMPONENT</u>	<u>QUANTITY</u>
Diode, 1N1116A	2
Diode, 1N2069 (RR-1002BB)	6
Diode, 1N2069 (RR-1002LB/RB)	4
Diode, 1N3569	5
Diode, 1N2974B	1
Diode, 1N1362	1
Diode, 1N2992	1
Fuse, 2 AMP, Slo-Blo	1
Fuse, KAA-2	1
Fuse, 1/2 AMP	1
Transistor, CDT 1313 or 2N1542 (RR1002BB)	4
Transistor, CDT 1313 or 2N1542 (RR-1002LB, RR-1002RB)	3

Table 1-3. A list of the fuses and semiconductors used in the reader.

#### 1.5 Options

Three Options are available for particular customer requirements which include:

- a. Ungated outputs in which the data outputs envelope the sprocket and appear independent of the sprocket track. Unless otherwise specified, the readers are supplied with the outputs gated, i.e., the information tracks appear at the same time as the feed hole track.
- b. Blocked outputs which inhibit all outputs during the manual re-winding of the tape. This cannot be used with automatic rewind and should be used with manual rewind only.
- c. Line stepping which allows the reader to step one line at a time with a pulse input.

Only the ungated output option is discussed in this manual. Each of the other two is described in a separate appendix and schematic if the option is used. Normally, the ungated option is specified along with the modes of operation at the time of purchase. However, if requirements change, it is a relatively simple matter, to modify the reader to achieve ungated outputs. Refer to Section 5.5.

## 1.6 Mode and Module Descriptions

So that a maximum in versatility may be achieved, the reader has been designed in such a manner as to provide a selection of voltage levels for the input feed control signals, the information track outputs and the sprocket track output. This is accomplished by making available various modules for certain areas of the circuitry and two possible sets of power supply levels. Figure 1-3 lists the various combinations from which the customer selects the one which is applicable to his requirements. The particular mode designated for this reader is indicated on the title page.

Three digits comprise the mode number with the first digit referring to the drive mode, the second to the data track output mode and the third to the feed track (sprocket) output mode. Refer to Tables I and II in Figure 1-3. Units with the line stepping (pulse coupling) option have had four added to the first digit; units with the blocked outputs have had four added to the second digit and units with the ungated outputs option have four added to the third digit. For example, a unit with normal mode 211 but containing the line stepping and ungated options would be 615.

Table II of Figure 1-3 lists the input voltage requirements and outputs obtained for each mode. As an example, a reader with drive mode 2, track mode 1 and feed track mode 2 would require 0V applied for the tape drive signal and +10V for the tape stop signal. Further, the voltage output for the data tracks would be +10V and 0V for a hole and no hole, respectively, and the feed hole track output would be 0V and +10V for a hole and no hole respectively. In addition, from Table I of Figure 1-3, this reader would use the following modules: X1, 101738; X2, 100857; X3-X6, 101735; X7-X8, 100858; X9, 101737 and X10, 101736.

Non-standard (special) units are denoted by an S, F or E and a two digit number in the last three digits of the model number. The differences between any special and the standard units are described in an addendum at the rear of the manual.

## 1.7 Tape Channel Numbering

Standard REMEX readers are equipped with an adjustable three channel tape guide containing the tape channel configurations shown in parts A, B, and C of Figure 1-4. This combination is normally called the teletype standard. Optional tape guides are available upon request at the time of purchase and include the following:

EIA Standard, adjustable three channel tape guide, configuration A, B, and D of Figure 1-4.

Eight Channel only.

Seven Channel only.

Five Channel only. ( Configuration D of Figure 1-4.).

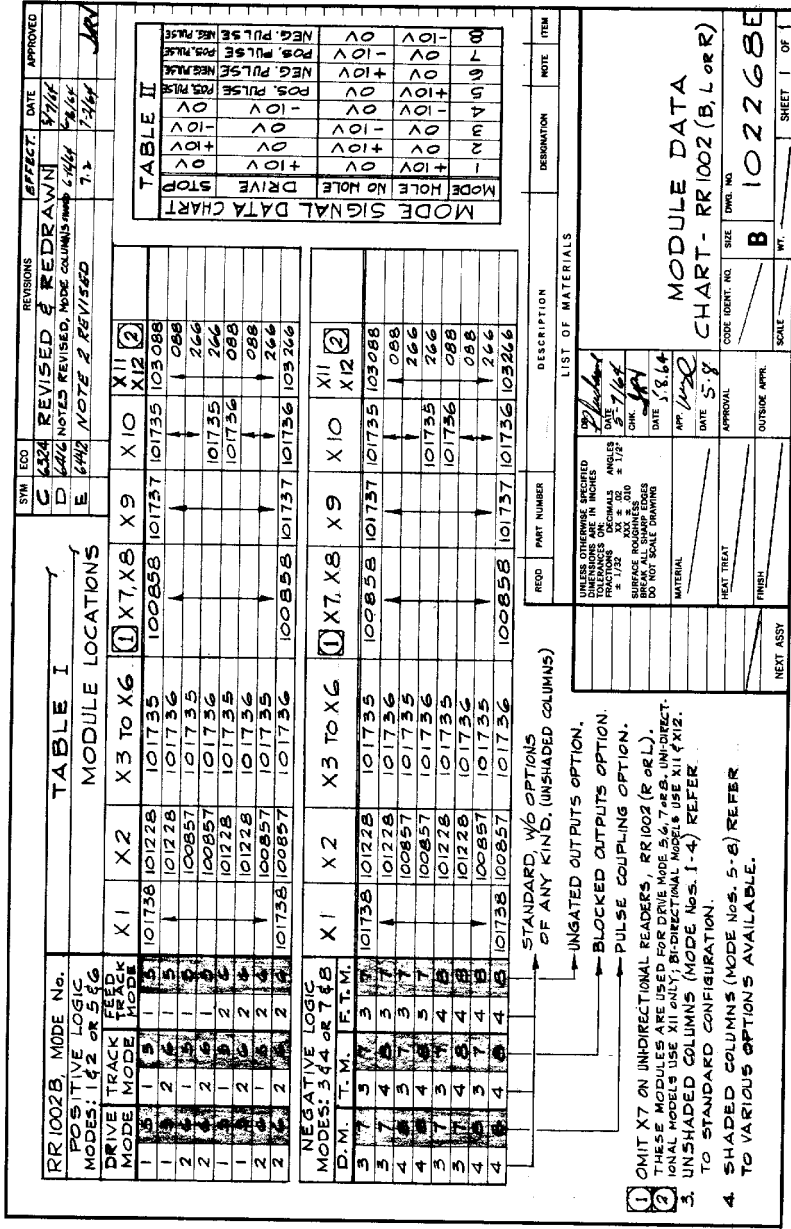

Figure 1-3. Mode and Module Data Chart for the REMEX Reader, Models RR-1002BB, RR-1002LB and RR-1002RB.

Each of the four configurations shown in Figure 1-4 employs the same photocell block containing eight data cells and one sprocket cell. These nine cells are numbered the same regardless of the type of tape with the same numbering also appearing on the schematics. Consequently, when using a 5 channel guide it is necessary to convert from the REMEX track number to the actual tape track number with the aid of Figure 1-4. For example, with the inverting five channel guide of configuration C, track 3 on the tape is the same as track 4 on the schematic and appears at pin 10 of connector J1. Particular cells which are not used will always contain a logic "1" signal since these cells will always be energized. To illustrate, REMEX track numbers 1, 7 and 8 will always be true when using the five channel guide of configuration C. This arrangement of tape guides allows the sprocket track to be recognized always as the sprocket.

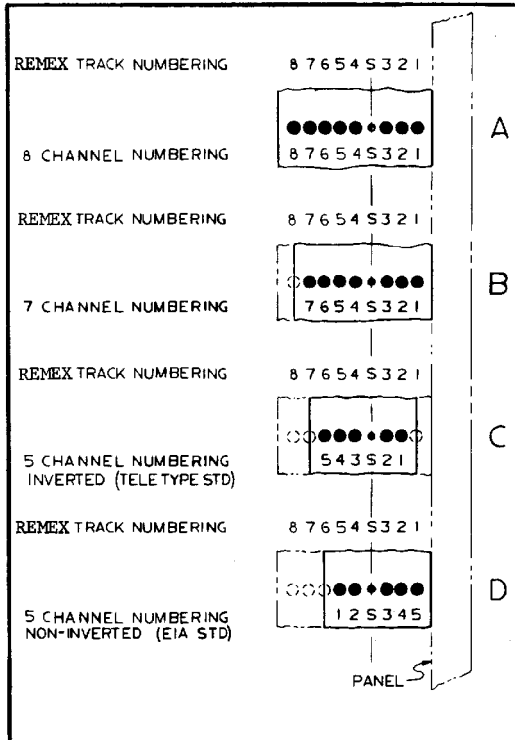

Figure 1-4  
 Various types of tape configurations showing how the track numbering on the tapes corresponds to the track numbering in the cell block.

## SECTION 2

### INSTALLATION

#### 2.1 Unpacking

Specially designed, reinforced packing cartons have been used in the shipment of the reader to provide the best possible protection during transit. Also packed with the unit are those items listed in Section 1.2. A careful visual inspection of the unit should be made as soon as it is removed from the carton for any apparent damage incurred during shipping. In the event the equipment has been damaged as a result of shipping, the carrier and REMEX Electronics should be notified as soon as possible.

#### 2.2 Power and System Connections

All power requirements, control signals and output signals which are necessary for complete operation of the reader with a given system are routed through J1 which is located at the rear of the reader. Figures 7-1 through 7-3, schematics, give the detail routing and pin connections of the signals applied to J1. No track output should have a load which exceeds 10 milliamps of current.

If a REMEX spooler is used with the reader, a direct connection is made from J2 on the reader to J2 on the spooler. Some spoolers have connector J2 with number pin designations and some have letter designations. Still others have a terminal strip instead of a connector. Always refer to the interconnection section of the spooler manual. Wires terminating at pins 11, 14, 15 and 19 on P1 (the mating connector for J1) and pins 1, 2 and 3 on P2 (the mating connector of J2) should be size 20 gage. All other cable wires should be 22 gage.

#### 2.3 Reader Mounting

To insure a minimum of acoustical noise and vibration to the surrounding equipment, the reader should be securely mounted. When mounting the reader in a closed cabinet, adequate air circulation should be supplied so that the reader does not exceed the ambient temperature specifications listed in Section 1.3. Each reader has been accurately adjusted and aligned before leaving the factory and should not require any initial adjustments or calibrations.

## SECTION 3

### OPERATION

#### 3.1 Warm Up

A brief period of at least 30 seconds should be allowed, after the power has been turned on, for the voltages to stabilize. This is particularly important when making any of the measurements referred to in Section 5, Maintenance.

#### 3.2 Motor Speed Control

A two speed motor allows the tape to be read at 500 characters/second or at 1000 characters/second. Relay K1 is used to select the desired speed. When the relay is de-energized, the 500 character/second speed is obtained. Energizing the relay produces the 1000 character/second speed. The relay is energized by applying signal ground to pin 13 of J1, regardless of the mode. Removing this signal de-energizes the relay.

#### 3.3 Operating Instructions

The following procedure should be followed when reading a tape, regardless of the operating modes being used with exception to steps i and j. Refer to Figure 1-1 for the location of the switches. Make sure the system installation and connections of Section 2.2 have been made. If the reader is not connected to the system, during such times as maintenance, the data and sprocket track outputs must be loaded with a 1K load to ground (Modes 1 and 4), to +10VDC (Mode 2) or to -10VDC (Mode 3). This is due to the fact that the output circuits in the reader are not internally loaded and must be connected either to the normal system load or to the externally connected load as described.

- a. Place the POWER switch into its ON position.
- b. Place the RUN-LOAD switch into its LOAD position. This will stop the capstan from rotating, release the brakes and pinch rollers, and remove power from the spooler.
- c. Lower the tape guide on the photocell assembly to its bottom stop. This is accomplished by pushing down on the tape adjuster from the top of the photocell block.
- d. Insert the tape to be read. Proper insertion usually requires that the edge of the tape nearest the feed hole be placed next to the panel. Refer to Section 1-7.
- e. Check for proper alignment of the tape within the guides.
- f. Raise the tape guide one stop for 8-channel tape, two stops for 7-channel tape and three stops for 5-channel tape.
- g. Place the RUN-LOAD switch into its RUN position.
- h. Select the desired speed. Refer to Section 3.2, Motor Speed Control.
- i. Apply the proper input feed control signal for the drive mode of the reader being used. Refer to Table 3-1 and to Section 1.6. The feed control signal is applied to pin 8 or 18 of J1 for right (forward) or left (reverse) movement, respectively.



When driving tape in a given direction, make sure the stop signal is applied to the pin for the opposite direction. The resulting output signals are listed in Table 3-2.

- j. To stop the tape movement, apply the stop signal as listed in Table 3-1 to both pins 8 and 18 of J1 for Model RR-1002BB, to pin 8 only for Model RR-1002RB or to pin 18 only for Model RR-1002LB.
- k. To unload tape, apply the stop signals, place the RUN-LOAD switch into its LOAD position, lower the tape adjustor and remove the tape.
- l. To remove power from the reader, place the POWER switch into its OFF position. The spooler may be used with the reader power off, if the RUN-LOAD switch on the reader is in RUN position.

Drive State	Positive Logic		Negative Logic	
	Mode 1	Mode 3	Mode 2	Mode 4
Run	+10V	0V	0V	-10V
Stop	0V	-10V	+10V	0V

Table 3-1. The required drive control inputs for the standard four modes.

Output State	Positive Logic		Negative Logic	
	Mode 1	Mode 3	Mode 2	Mode 4
Hole	+10V@10 milliamps	0V@10 milliamps	0V@10 milliamps	-10V@10 milliamps
No Hole	0V@<50 microamps	-10V@<50 microamps	+10V@<50 microamps	0V@<50 microamps

Table 3-2. The output signals for the standard four modes.

### 3.4 Operational Maintenance

After every 6 to 8 hours of use, the operator should check the condition of the glass slide covering the aperture plate for dirt or foreign material. This is extremely important since anything covering the apertures can create errors in readout. Use the bristle brush supplied with the reader for general cleaning. Use a cotton swab and water, if necessary, to remove foreign matter.

## SECTION 4

### THEORY OF OPERATION

#### 4.1 Reader Operational Descriptions

Three main functions are performed by the circuitry in the tape reader: (1) transport control, (2) tape perforation sensing and output and (3) the supply of power and light. Certain areas of the transport control and tape perforation sensing and output circuits have been incorporated into ten modules (X1-X10). Refer to Figures 7-1 through 7-3. These are the following:

- a. Transport Control
  - (1) The input control circuit, X2.
  - (2) The drive and brake amplifiers, X7 and X8, respectively, which are two identical modules.
  
- b. Tape Perforation Sensing and Output
  - (1) The Schmitt trigger, X1.
  - (2) The emitter switch and delay circuit, X9.
  - (3) The five track output amplifier modules (X3-X6, X10) in which one module, X10, supplies the sprocket output and each of the other four, X3-X6, supply two tracks each.

Each of the three functions is discussed below. The particular modules used with the various modes are discussed in Section 1.6 and listed in Figure 1-3.

##### 4.1.1 Transport Control Circuits

Applying the drive feed signal to the bi-directional model as described in Section 3.3 to pin 1 or pin 6 of X2, depending upon the direction desired, generates the output signal at pin 3 or pin 7, respectively. This signal is, in turn, applied to pin 1 or 7, respectively, of X8 where it is amplified and produces an output at pin 6 or 8 of X8. Transistor Q1 or Q2 is subsequently turned on, thereby energizing the selected drive magnet. At the other output of X8, pin 8 or 6, the appropriate drive transistor remains off.

When a drive signal is present at either pin 1 or 6 of module X2, an output is generated at pin 9 of X2 which is amplified by module X7. This signal then appears at pins 8 and 6 of X7 and is used to turn off Q3 and subsequently release the brakes, L3 and L4.

Two separate drive systems are incorporated in the bi-directional model, one on each side of the reading head. On the right is placed the forward drive and on the left, the reverse drive. A continuously rotating capstan and an electromagnetically operated pinch roller constitute the drive system. Refer to Figure 5-1. When a drive magnet is energized (the brakes are simultaneously released), a rocker arm assembly, connected mechanically to the pinch roller, is actuated by the resulting magnetic field. This causes the

pinch roller to force the tape against the capstan, resulting in the tape being pulled through the reader.

When the stop signal is applied to both pins 1 and 6 of X2, the output signal from pin 9 is generated and applied to pins 1 and 7 of the brake amplifier module, X7. These signals are, in turn, amplified by X7 and produce outputs at pins 6 and 8 which cause Q3 to turn on. Both brake magnets are then energized, stopping the tape.

The brake system is composed of two high speed d.c. electromagnets located below the normal tape path. Refer to Figure 5-2. As the magnets are energized, each one actuates a brake shoe housed above the tape which clamps the tape to the magnet housing. This double braking action insures accurate and rapid stopping.

Models RR-1002LB and RR-1002RB use only two modules, X2 and X8, in the transport circuit. One half of X8 is used as the drive amplifier and the other half is used as the brake amplifier. The same pin connections, however, are applicable with pins 3 and 7 of X2 used as the right and left drive outputs, respectively, and pin 9 used as the brake output.

#### 4.1.2 Perforation Sensing and Gated Output Circuits

Nine photovoltaic cells in the read head (part of the photocell block assembly) are used to sense, photoelectrically, the perforations in the tape. A light source (refer to Section 4.1.3, Lamp and Power Supplies) provides a focused beam which covers the area of the photocells as shown in Figure 5-4. The tape is pulled over the top of the photocell block and when a hole in any given track on the tape appears over the top of a photocell, the light shining through the hole, energizes the cell.

Connected to each photocell is a two stage amplifier (modules X3-X6 and X10) which provides the proper output voltage for use in external circuits. Operation of the amplifiers depends upon two factors: (1) the cell must be energized by the light and (2) the voltage level of the emitter common line of all amplifiers, pin 1 of modules X3-X6 and X10, must be lowered.

Control of the emitter line voltage is achieved by recognizing the presence of the feed hole in the following manner. As the feed hole cell becomes energized, the voltage at the anode of the photocell rises a few tenths of a volt which is applied to the input, pin 8, of the Schmitt trigger module, X1. This generates an output signal at pin 3 of X1 which is applied to pin 5 of the emitter switch and delay module, X9.

Two outputs, in turn, are generated from module X9. One output, from pin 6, is the emitter common line whose voltage drops to approximately that of the photocell common line. Potentiometers R11 through R18 and current limiting resistors R19 through R26 provide sufficient negative bias at each amplifier base (pins 8 and 9 of the output amplifier modules, X3-X6) such that if any track cell has not been energized, and the emitter line has been lowered, the output amplifier of that track will not be turned on. A rise in voltage at the anode of an energized photocell, however, turns on the track amplifier. Each potentiometer is adjusted to compensate for the variations in the output of each track cell as described in Section 5.2.7. The adjustment of the BIAS potentiometer, R8, which supplies the common voltage to R11 through R18 is also described in the same procedure.

The second output from X9, pin 3, is delayed approximately 15 microseconds and then applied to pin 8 of the feed hole amplifier (in module X10). This results in the feed hole output appearing approximately 15 microseconds after that of the other eight tracks. A similar situation occurs when the amplifiers are turned off. In this instance the emitter switching line is delayed, resulting in the feed hole output being removed before the other tracks. Such a sequence is referred to as the gated output condition since the appearance of the data tracks depends upon the sensing of the sprocket. Section 4.2 describes the optional arrangement in which the data outputs appear independently of the sprocket (ungated condition).

#### 4.1.3 Lamp and Power Supplies

The light source is an axial cartridge lamp especially selected to provide a long average life. Care must be taken to properly focus the lamp and to assure that no obstructions such as dirt, incomplete tape perforations, etc., cover the cell block apertures. Positioning of a new lamp is discussed in Section 5.2.3, Lamp Changing.

All necessary d.c. voltages required for the internal operation of the circuits are derived from the power supply section. A constant voltage transformer, together with D1 and D2 and filtering capacitor C1, comprise the basic 60VDC power supply. A 10 volt zener diode, Z1, and a string of five diodes, D11-D15, provide the proper operating levels for the modules. Transistor Q4 provides regulation for the reading lamp and the bias potentiometer, R8.

The different voltage levels required for modes 1 or 2 and modes 3 or 4 are achieved internally. This is accomplished by tying pin 14 of J1 (which is signal ground in all four modes) to the anode of Z1 (-10V line) for modes 1 and 2 and to the cathode of Z1 (0V line) in modes 3 and 4. Refer to the notes incorporated on the Schematics (Figures 7-1, 7-2, and 7-3). With reference to signal ground, pin 17 of J1 and pin 18 of J2 is -56VDC in modes 3 and 4 and -46VDC in modes 1 and 2. Likewise, all other voltages

become more positive by 10 volts in modes 1 and 2. For example, the +4VDC of modes 3 and 4 become +14VDC with respect to signal ground and also appears at pin 10 of J2 as +14VDC.

#### 4.2 Ungated Output Option

Certain reader applications require that the track outputs appear independently of the sprocket track, i.e., the track outputs are not gated with the sprocket track. This results in the sprocket coming on approximately 10% of hole to hole cycle time after the data tracks are turned on and disappearing the same amount time before the data tracks. Two jumper wires are used to accomplish this. Refer to the Schematics, Figures 7-1 through 7-3. This ties the photocell common line and the emitter common line of the track amplifiers to -10VDC. Track outputs, then, depend only upon the rise in the voltage at the anode of its respective photocell and not the change in the emitter common line (which for gated outputs is produced by the sensing of the sprocket). To offset the difference in hole sizes of the sprocket and data tracks on the tape, a special aperture mask is also used in which all holes are the same size. A special alignment procedure is used with this option as described in Section 5.2.8.

## SECTION 5

### MAINTENANCE

The REMEX Tape Reader has been designed in a manner as to keep maintenance as simple and infrequent as possible. To prolong the life of the equipment, certain checks and preventative procedures are set up in Section 5.1 with suggested schedules. From time to time, certain adjustments and calibrations may be needed. These are detailed in Section 5.2, accompanied by the necessary diagrams. Additional information which may be helpful is included in Sections 5.3 through 5.5.

#### 5.1 Preventative Maintenance

Item	Time	Procedure
Photocell Block	Semi-Weekly or more frequently as required.	Check the condition of the glass slide covering the aperture plate. This is extremely important since any dirt or foreign material covering an aperture can create errors in readout. A stiff bristle brush is included for general cleaning. Use a cotton swab and water, if necessary, to remove foreign matter.
Focusing Lens	Semi-Weekly	Check and clean if necessary. Use the same materials for cleaning as mentioned in the Photocell Block item.
Jam and Drive Rollers	Semi-Weekly	Check for the following: a. Cleanliness of the surface. Cleaning is easily accomplished by abrading their surfaces with a soft eraser of the "Pink Pearl" type. b. Wear or indentations on the roller surfaces.
Brake Shoes	Semi-Monthly	Check for accumulation of foreign matter that might tend to reduce the braking force and clean, if necessary. Refer to Section 5.2.2.

Item	Time	Procedure												
Power Supply Voltages	Quarterly	<p>Check all voltages listed below with the same voltmeter. A change in voltage readings may be indicative of a gradual component failure. A period of about 30 seconds should be allowed for warm up before the readings are taken.</p> <p>All voltage readings should be <math>\pm 5\%</math>. Refer to Section 7, Figure 7-11 for identification of components and terminal locations.</p> <table border="0" data-bbox="646 487 958 596"> <thead> <tr> <th><u>Voltage</u></th> <th><u>From</u></th> <th><u>To</u></th> </tr> </thead> <tbody> <tr> <td>-56VDC</td> <td>Cl,-terminal</td> <td>TP1</td> </tr> <tr> <td>-10VDC</td> <td>F3, terminal 2</td> <td>TP1</td> </tr> <tr> <td>+4VDC</td> <td>Cl,+terminal</td> <td>TP1</td> </tr> </tbody> </table>	<u>Voltage</u>	<u>From</u>	<u>To</u>	-56VDC	Cl,-terminal	TP1	-10VDC	F3, terminal 2	TP1	+4VDC	Cl,+terminal	TP1
<u>Voltage</u>	<u>From</u>	<u>To</u>												
-56VDC	Cl,-terminal	TP1												
-10VDC	F3, terminal 2	TP1												
+4VDC	Cl,+terminal	TP1												
Lamp Voltage	Monthly	Check the voltage across the reading lamp. Refer to Section 5.2.4.												
Symmetry of Sprocket Track Output	Anytime a tape material changes or a lamp is replaced	Check the sprocket output at test points 1 and 2 for a 45% on time for readers using gated outputs. Refer to Section 5.2.5. Readers containing the ungated output option should be checked for a 40% on time. Refer to Section 5.2.6.												

CAUTION: WHEN REMOVING OR MOUNTING ANY COMPONENTS ON THE CERAMIC STRIPS, USE ONLY SOLDER COMPOSED OF 4% SILVER, 60% TIN, AND 36% LEAD. SOLDER NOT CONTAINING A SMALL AMOUNT OF SILVER WILL RESULT IN COLD SOLDER JOINTS AND DAMAGE TO THE STRIPS.

## 5.2 Adjustments and Calibrations

Proper operation depends upon making and maintaining accurate adjustments. The following calibrations should be checked periodically and adjusted as needed.

### 5.2.1 Drive System Adjustment

The following procedure describes the adjustments between the capstan, the rocker assembly and the magnet. Figure 5-1 illustrates the left drive system; the right drive is the mirror image.

- a. Remove any tape which may be in the reader.
- b. Energize the drive magnet. Refer to Section 3.3, step i. This should bring the pinch roller in contact with the capstan and the gap between the rocker assembly and the magnet surface should be as shown in Figure 5-1, Step 1.
- c. If the conditions do not exist as described in step b, loosen the magnet holding screws and move the magnet assembly slightly until the desired gap is obtained when the rollers are in contact.
- d. Tighten the magnet holding screws, being careful not to disturb the setting made in step c.
- e. De-energize the drive magnet. Refer to Section 3.3, step j.
- f. With the magnet de-energized, the rocker stop and the rocker assembly should be in contact and the gap between the capstan and pinch roller should be as shown in Figure 5-1, Step 2.
- g. If the conditions do not exist as described in step f, loosen and adjust the rocker stop screw until the desired gap is obtained.
- h. Tighten the rocker stop, being careful not to disturb the setting made in step g.

### 5.2.2 Brake Magnet Cleaning Procedure

The type of brake used on the reader requires no adjustment. A semi-monthly check for cleanliness, however, is required. Cleaning of the brake, when necessary, is accomplished in the following manner:

- a. Remove the upper cover. Refer to Figure 7-13, item 10.
- b. Loosen the two #4-40 allen screws which hold the brake shoe housing (top half of the brake).
- c. Gently insert a screw driver under the brake shoe to keep the parts intact while carefully removing the housing from the mounting block. Leave the mounting block secured to the panel.
- d. Clean the accumulated material from the housing, the brake shoe, the spring and the face of the magnet (top surface of the mounting block). Use water or alcohol, if necessary, to remove the residue.
- e. Reassemble the brake shoe housing as shown in Figure 5-2 and remount it to the mounting block.



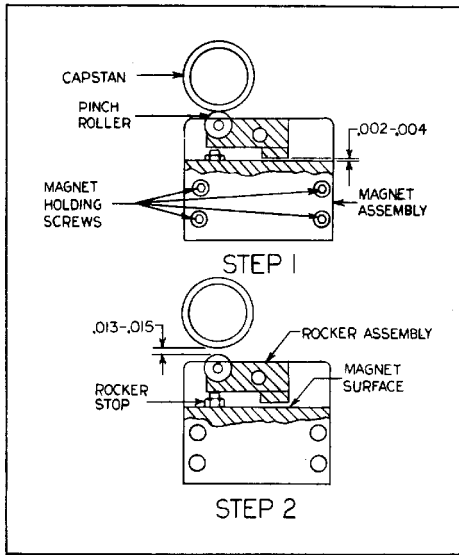

Figure 5-1.

The drive mechanism of the reader showing its two step adjustment procedure.

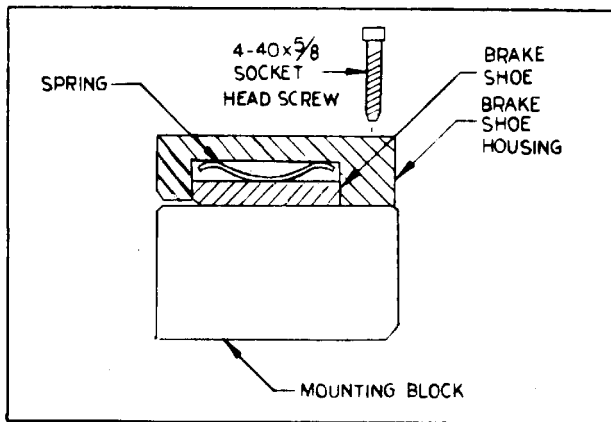

Figure 5.2.

A cross section of the side view of the brake magnet showing the assembly of the brake shoe housing. It is important for maximum braking action that the spring be placed as shown and not inverted.

### 5.2.3 Lamp Focusing

When replacing a lamp, make certain the filament is parallel with the holes in the photocell block and that the focused beam will just cover all the holes. The light pattern should appear as shown in Figure 5-4.

Due to small variations in construction, from lamp to lamp, it may be necessary to rotate the lamp. Long nose pliers may be used on the base of the lamp. Care should be taken so as not to break loose the base. It may also be necessary to loosen the lamp bracket mounting the screws and move the bracket slightly to obtain the desired beam. Refer to Figure 5-3. In addition, check the voltage across the lamp. Refer to Section 5.2.4. It may also be necessary to check the symmetry adjustment. Refer to Section 5.2.5 or 5.2.6.

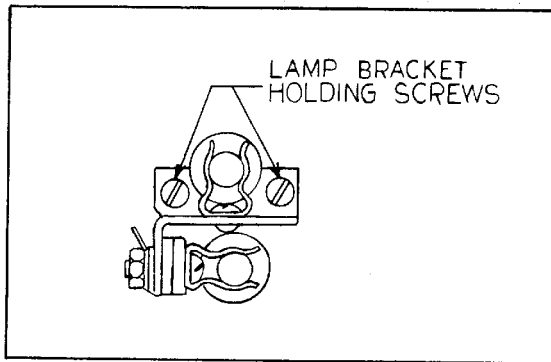

Figure 5-3.

Lamp mounting bracket showing the locations of the holding screws.

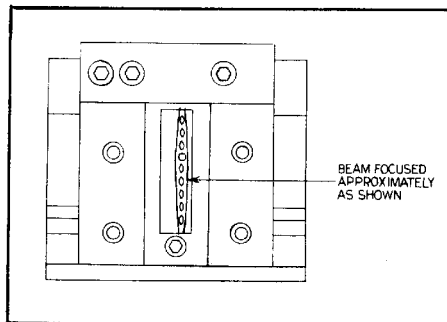

Figure 5-4.

Focused beam of the lamp showing its proper alignment.

#### 5.2.4 Lamp Voltage Adjustment

The following procedure insures that the proper voltage is applied across the reading lamp:

- a. With the POWER switch in the OFF position, place a voltmeter across the terminals of the lamp fixture.
- b. Place the POWER switch into its ON position.
- c. Adjust potentiometer R7 until the voltmeter reads 20.0 VDC. Make sure this reading is made after the lamp has reached steady state conditions.
- d. Remove the voltmeter leads.

#### 5.2.5 Symmetry Adjustment, Gated Outputs

The symmetry adjustment may be required in both of the following instances:

- a. When a lamp has been replaced.
- b. For any change in tape material where there is a significant opacity variation.

This adjustment is performed as follows:

- a. Insert a tape with feed holes only.
- b. Apply the feed signal. Refer to Section 3.3, step i.
- c. Place the oscilloscope ground lead in black test jack, TP1.
- d. Place the oscilloscope probe in the red test jack, TP2.
- e. Adjust the SYMMETRY potentiometer R9 for a 45% "on time" as shown in Figure 5-5.

Note: A standard voltmeter may be substituted for the oscilloscope. In such cases, adjust the symmetry potentiometer to obtain an average d.c. level equal to 45% of the actual value of the +10 volt supply (Mode 1), to 45% of the -10 volt supply (Mode 4) to 55% of the +10 volt supply (Mode 2) or to 55% of the -10 volt supply (Mode 3).

#### 5.2.6 Symmetry Adjustment, Ungated Outputs

The symmetry adjustment for readers containing the ungated output option is the same as described in Section 5.2.5 with one exception. In step e, adjust the SYMMETRY potentiometer, R9, for a 40% on time instead of 45% and a 60% off time instead of 55%.

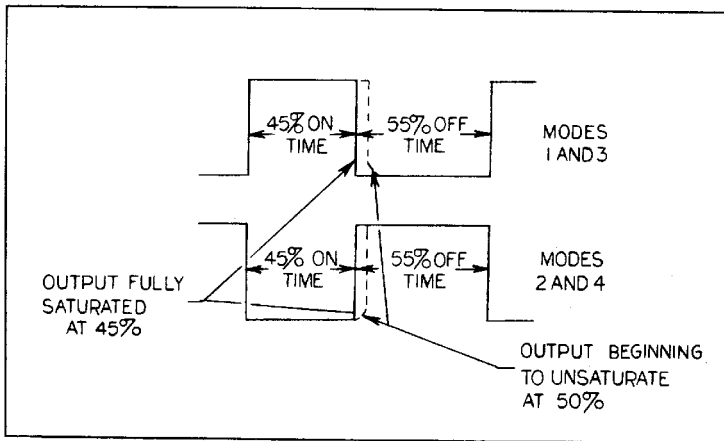

Figure 5-5.

The sprocket output (TP1-TP2) when the symmetry is properly adjusted for readers with gated outputs. Readers with ungated outputs are adjusted for a 40% on time and a 60% off time.

#### 5.2.7. Alignment Procedure, Gated Outputs

After a new lamp has been mechanically focused, check the outputs using the following procedure for only those readers with gated outputs.

- a. Insert a tape having a light transmissivity of 50%, and containing holes in all tracks.
- b. Connect a 1K load to the output of each track.
- c. Start the reader and observe all outputs. Refer to Section 3.3, step i. They should be of the form shown in Figure 5-5, fully saturated throughout the "on time".
- d. Insert a tape having a light transmissivity of 50% and containing feed holes only.
- e. Start the reader and observe the outputs of the tracks with no holes. The leakage through the tape, as observed at the outputs, should be less than 200 millivolts.

If the lamp has been adjusted properly (Refer to Section 5.2.3), steps c and e will normally be correct. In the event, after rotating the lamp and adjusting the lamp bracket, the conditions in steps c and e cannot be obtained, continue the above procedure with the following steps. It should be noted that steps f through o will allow the reader to read the extreme range of light transmissivities (0 to 50%). However, if its desired to read only one type of tape, the BIAS potentiometer R8 may simply be adjusted until the outputs appear as indicated in steps c and e.

- f. Insert a tape as described in step a.
- g. Adjust potentiometers R11-R18 to their maximum resistance (fully clockwise). Then back off 2 full turns (CCW).
- h. Adjust the BIAS potentiometer R8 for the maximum voltage (i.e., the negative value nearest zero). The voltage measurement is made from the yellow test point (TP3) to the black (TP1).
- i. Adjust the SYMMETRY potentiometer R9 for a 50% "on time". Refer to Section 5.2.5.
- j. Reduce the bias (increase the negative value) until one of the track outputs just begins to come out of saturation. Refer to Figure 5-5.
- k. Adjust the trim potentiometers R11-R18 of the other seven tracks until their outputs appear as described in step j.
- l. Adjust the SYMMETRY potentiometer R8 for a 48% "on time." The outputs of all tracks should be full saturated.
- m. Insert a tape as described in step d.
- n. Adjust the Symmetry potentiometer R8 for a 45% "on time".
- o. Observe the outputs of the tracks with no holes. The leakage through the tape, as observed at the outputs, should be less than 200 millivolts.

#### 5.2.8 Alignment Procedure, Ungated Outputs

The following procedure is used only with those readers containing the ungated output option. This procedure aligns the reader after the lamp and lamp bracket, if necessary, have been properly adjusted. Refer to Section 5.2.3.

- a. Insert a tape of the type to be used with holes in all tracks.
- b. Make sure the reader is connected to the equipment with which it is used. If the reader cannot be connected, load each output track with a 1K load to ground for Modes 1 and 4, to +10VDC for Mode 2 or to -10VDC for Mode 3.
- c. Start the reader (Refer to Section 3.3, step i) and observe the sprocket output which should be on 40% of its cycle and off the remaining 60%. If this is not the case, adjust the SYMMETRY potentiometer R9 for a 40% on and 60% off cycle. Refer to Section 5.2.6. Note, however, that the symmetry for the ungated condition is 40% on and 60% off, not the 45% on and 55% off as stated in the procedure for the gated condition. Lock the SYMMETRY potentiometer.
- d. Adjust potentiometers R1 - R8 to their maximum resistance (fully clockwise) and back off 2 full turns (counterclockwise).
- e. Observe all eight data track outputs and note the track with its output on for the least amount of time.
- f. Adjust the BIAS potentiometer R8 for a 60% on time and a 40% off time for the track noted in step e. Lock the BIAS potentiometer.
- g. Adjust the trim potentiometers of each of the remaining data tracks until the respective track output has an on time of 60% and an off time of 40%.

### 5.3 Tape Splicing Instructions

In the event of tape breakage, it is recommended that a butt splice be used to repair the tape. A butt splice is made by bringing the ends of the tape together without any overlapping and securing them firmly together with the splicing material. Refer to Figure 5-6.. A recommended splicing material is the silver Scotch tape #852. Care should be exercised to make certain the splicing material ends between feed holes and that the splicing material is trimmed coincident with the edge of the tape.

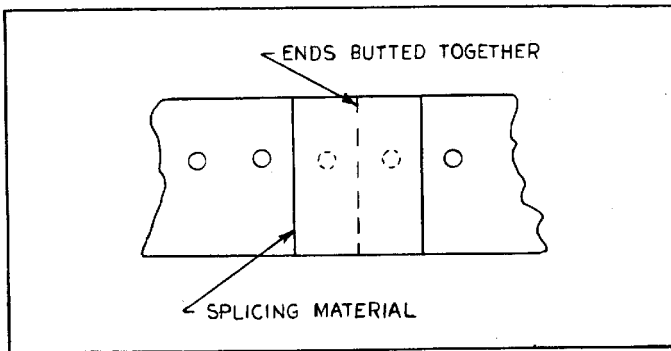

Figure 5-6.

A sample tape showing a properly made splice.

### 5.4 Determination of Per Cent Light Transmissivity of a Tape

Semi-transparent tapes which allow up to 50% of the light applied to pass through are capable of being read by the photocell block. Any higher level may energize photocells where perforations do not exist, thereby giving false outputs. The method of determining the % light transmissivity is as follows:

- a. Remove the plug P3 on the photocell block.
- b. Connect a 100 ohm,  $\frac{1}{2}$  W resistor across pins 4 and 10 of J3.
- c. Place the leads of a high impedance voltmeter (preferably a digital voltmeter) across the 100 ohm resistor.
- d. Turn on the lamp of the reader and, with no tape in the reader, record the voltmeter reading.
- e. Insert the tape to be measured with no holes in any of the tracks. Position the tape to give the highest reading.
- f. Record the voltmeter reading.
- g. Divide the voltage obtained in step d. into that obtained in step f. Multiply by 147% to give the percent transmissivity.
- h. Remove the tape and resistor and replace P3.

### 5.5 Gating and Ungating the Outputs

As described in Sections 1.5 and 4.2, the reader is normally supplied with gated outputs unless otherwise specified at the time of purchase. However, if requirements change, it is a relatively simple matter to modify the reader to achieve the new specifications. If the reader's outputs are gated, they may be ungated by adding two wires, one from pin 4 to pin 6 on module socket X9 and the other from pin 6 to pin 7, again on socket X9. Conversely, removing these wires will provide gated outputs. Refer to Figures 7-1, 7-2 and 7-3.

## 5.6 Disassembly and Reassembly Procedures

Listed below are the procedures to be followed when disassembling and reassembling various parts of the reader.

### 5.6.1 Lamp Replacement

The following steps are to be followed when replacing a lamp.

- a. Loosen the two screws under the lamp cover (item 10, Figure 7-13) which hold it to the panel.
- b. Lift the cover up and away from the panel.
- c. Remove the burned out lamp and replace it with a new one. One spare lamp is provided on the top of the lamp bracket assembly (item 15, Figure 7-13).
- d. Perform the procedure as described in Section 5.2.3.
- e. To reassemble, perform the reverse of steps b and then a. Check procedures 5.2.3, 5.2.4, 5.2.5 (or 5.2.6) and 5.2.7 (or 5.2.8) as required.

### 5.6.2 Readout Assembly (Photocells) Replacement

The following steps are to be followed when replacing a readout assembly.

- a. Remove the two screws from each end of the lower cover (item 11, Figure 7-13) and remove the cover.
- b. Unplug P3 from the photocell assembly (Figure 7-11).
- c. Remove the two allen screws which hold the photocell block assembly to the front panel.
- d. Pull down and out to remove the photocell assembly from the front panel.
- e. Pull the tape adjustor on photocell assembly down.
- f. Remove the screws at each end of the rear tape guide, but do not remove the screw holding the lens..
- g. Invert the photocell block and lay it down on a protective surface.
- h. Remove the two screws holding J3.
- i. Take the photocell block assembly in hand and remove the allen screw from each end of the readout assembly.
- j. Lift the readout assembly up endwise and pass it down through the photocell block.
- k. To reassemble the readout assembly, feed the readout assembly up from the bottom of the photocell block.
- l. Orientate the readout assembly so that the serial number of the readout assembly is toward the front.
- m. Insert the two allen screws but do not tighten.
- n. Orientate J3 so that pin 1 is toward the front of the photocell block assembly.
- o. Insert a fully punched tape into the photocell assembly and raise the tape adjustor.
- p. Adjust the readout assembly so that the cell apertures appear in the center of each hole of the punched tape. Make this alignment as carefully as possible. Tighten the allen screws. REMEX has available a gauge (part number 103569-1 for an eight-channel tape guide or 103569-2 for a five-channel only tape guide) to assist in the alignment. CAUTION: Some photocell block assemblies have various parts made of plastic. Care should be taken when tightening the screws in the plastic assemblies that they are not overtightened.



- q. Install the rear tape guide and insert the allen screws but do not tighten.
- r. Move the rear tape guide in toward the tape. Do not pinch the tape and do not leave any gap between the tape and guide. Tighten the allen screws and recheck the alignment. The special gauge referred to in step p is useful in this alignment also.
- s. Perform the reverse of steps d, c, b, and then a.
- t. Align the reader with the procedure described in Sections 5.2.3, 5.2.4, 5.2.5 (or 5.2.6) and 5.2.7 (or 5.2.8) as required.

#### 5.6.3 Module Replacement

The following procedure is recommended when replacing any of the modules.

- a. Remove the module cover (item 13, Figure 7-13) which covers the modules (Figure 7-12).
- b. Replace the required module. Refer to Figure 7-12 for module arrangement and to the schematic for the function.
- c. Replace the module cover.
- d. Check the alignment of the reader and realign as required using the procedures in Sections 5.2.3, 5.2.4, 5.2.5 (or 5.2.6) and 5.2.7 (or 5.2.8) as required.

#### 5.6.4 Brake Replacement

The following procedure is recommended when replacing a brake.

- a. Remove the two screws from each end of the lower cover, (item 11, Figure 7-13) and remove the cover.
- b. Remove the electronic chassis cover (item 9, Figure 7-13).
- c. Unsolder the wire coming from the right brake (L3) at terminals F-4 and D-3 or the left brake (L4) at terminals F-4 and A-3 (refer to Figure 7-11).
- d. Remove the two allen screws on the bottom half of the brake.
- e. Reassemble the brake by performing the reverse of steps d, c, b and then a.

#### 5.6.5 Drive Magnet Replacement

The following procedure is recommended when replacing the drive magnet assembly.

- a. Remove the two allen screws from each end of the lower cover (item 11, Figure 7-13) and remove the cover.
- b. Remove the electronic chassis cover (item 9, Figure 7-13).
- c. Unsolder the four wires coming from the left drive magnet (L1) at terminals A-2, F-2, F-7 and F-7 or from the right drive magnet (L2) at terminals A-1, F-2, F-9 and F-9. Refer to Figure 7-13. Note the color of the wire at each terminal so that the new wires will be placed at the same terminals.
- d. Remove the four allen screws on the bottom half of the magnet assembly.
- e. Reassemble the magnet assembly by performing the reverse of steps d and then c.

- f. Perform the adjustment procedure as described in Section 5.2.1.
- g. Perform the reverse of steps b and then a.

#### 5.6.6 Capstan Replacement

The following procedure is recommended when replacing the capstan.

- a. Loosen the set screw which holds the capstan to the drive shaft.
- b. Slide the capstan off.
- c. To reassemble, perform the reverse of steps b and then a.
- d. Perform the adjustment procedure as described in Section 5.2.1.

#### 5.6.7 Transformer Replacement

The following procedure is recommended when replacing the transformer.

- a. Remove the seven wires from barrier strip TB2. Note the color of wire at each terminal so that the new wires will be placed at the same terminals.
- b. Loosen the four screws holding the transformer to the panel bracket and remove the transformer.
- c. To reassemble, perform the reverse of steps b and then a.
- d. If the new transformer has a different color dot than capacitor CS, replace the capacitor with one containing the same color dot.

#### 5.6.8 Motor Replacement

The following procedure is recommended when replacing the capstan motor.

- a. Loosen the holding nuts from the POWER ON-OFF and RUN-LOAD switches and swing the switches out of the way.
- b. Remove the belt. Refer to Section 5.6.9.
- c. Remove the motor pulley by loosening the set screw which holds the pulley to motor shaft.
- d. Remove the pulley from the capstan drive shaft. This step allows access to the motor holding bolts.
- e. Remove the five motor wires from TB1. Note the color of wire at each terminal so that the new wires will be placed at the same terminals.
- f. Mark on the motor bracket the location of the present allen screws which hold the motor to the bracket. This will permit correct vertical alignment when reassembling.
- g. Remove the four allen screws which hold the motor to the motor bracket and remove the motor.

- h. To reassemble, perform the reverse of steps g, f, e, d, c, b and then a.
- i. Readjust the belt tension. Refer to Section 5.6.9.

#### 5.6.9 Drive Belt Replacement

The following procedure is recommended when replacing the drive belt.

- a. Loosen the one allen screw which holds the belt adjust assembly (item 3, Figure 7-12).
- b. Rotate the belt adjust assembly so that tension is removed from the belt.
- c. Remove the old belt.
- d. Install the new belt. Figure 5-7 illustrates the routing of the belt.
- e. Rotate the belt adjust assembly until the belt is tight. Tighten the allen screw on the belt adjust assembly.
- f. Apply a force of 6 ounces  $\pm$  1 ounce as shown in Figure 5-7. This should produce a deflection of approximately 1/8 inch.
- g. Repeat steps a and e as necessary to obtain the conditions as described in step f.

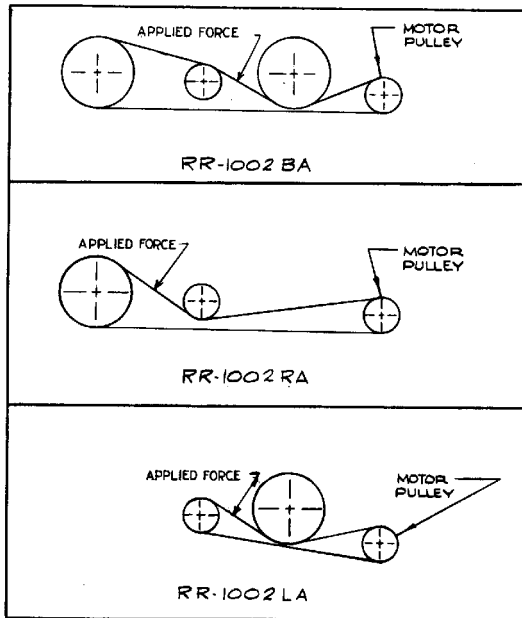

Figure 5-7.

Belt drive arrangement for high speed readers.

### 5.7 Typical Transistor Voltage Measurements

The following voltage measurements are useful when trouble shooting the reader. All measurements are  $\pm 10\%$ . Refer to Figure 7-12 for locations. All measurements were taken with the RUN-LOAD switch in the RUN position.

Terminal Location	Run-Stop Condition	Voltage Measurement
Base Q1, Q2	Run	+5.5V
	Stop	+2.5V
Collector Q1,Q2	Run	+7V
	Stop	-54.0V
Emitter Q1,Q2	Run	+0.8V
	Stop	+0.8V
Base Q3	Run	+2.6V
	Stop	+5V
Collector Q3	Run	-54.0V
	Stop	+7V
Emitter Q3	Run	+0.8V
	Stop	+0.8V
Base Q4	-	-48.7V
Collector Q4	-	-54.1V
Emitter Q4	-	-48.4V

Table 5-1.

A list of transistor voltage measurements for various locations in the reader.

5.3 Trouble Shooting Chart

Symptom	Probable Cause	Instruction
1. Intermittent track outputs.	Improper lamp focus.  Aperture glass on photocell block dirty.	Check lamp focus as described in Section 5.2.3.  Clean photocell block. Refer to Section 5.1, Photocell block item.
2. No track outputs, any track.	Improper lamp focus.  Bias or trim potentiometers improperly adjusted.	Check lamp focus as described in Section 5.2.3.  Check adjustment as described in sections 5.2.5 (or 5.2.6) and 5.2.7 (or 5.2.8).
3. Outputs present on all but one track.	Improper lamp focus.  Trim potentiometer improperly adjusted.  Module associated with that track defective.  Photocell defective.	Check lamp focus as described in Section 5.2.3.  Check adjustment as described in sections 5.2.5 (or 5.2.6) and 5.2.7 (or 5.2.8).  Replace module associated with the particular track and described in Section 5.6.3.  Check and replace readout assembly if defective as described in Section 5.6.2.
4. One track output too narrow or wide.	Improper lamp focus.  Trim potentiometer improperly adjusted.	Check lamp focus as described in Section 5.2.3.  Check adjustment of trim potentiometer as described in Section 5.2.7 (or 5.2.8).

Symptom	Probable Cause	Instructions
5. One track output at one half level.	Defective module.	Check module associated with particular track output and replace if defective. Refer to Section 5.6.3.
6. RUN-LOAD switch in RUN position, motor and lamp are on, tape does not drive.	Inhibit present from spooler	Check to see if inhibit is present from spooler and correct as necessary. Refer to Spooler manual.
	Fuse F3 blown.	Check fuse F3 and replace if blown.
	Drive module defective.	Check module X2, X7 or X8 and replace if defective.
	Diode D7 or Transistor Q2 defective.	Check diode D6 or D7 or transistor Q1 or Q2 and replace if defective.
7. Motor runs, lamp not lighted, voltages -56V and -10V are present.	Lamp failure.	Replace lamp and recheck lamp voltage. Refer to Section 5.2.4. Recheck lamp focus. Refer to Section 5.2.3.
8. Motor runs, lamp not lighted, voltages -56V and -10V are absent.	Fuse F2 blown.	Check fuse F2 and replace if blown.
9. Pinch roller operates, brake does not release in run mode.	Drive signal not correct.	Check drive signal from external equipment.
	Module X2, X7 or X8 defective.	Check module X2, X7 or X8 and replace if defective.
10. Brake does not come on when stop signal is applied. Tape does not stop on character.	Module X2, X7 or X8 defective.	Check module X2, X7 or X8 and replace if defective.
	Diode D8 or transistor Q3 defective.	Check diode D8 or transistor Q3 and replace if defective.

Symptoms	Probable Cause	Instructions
10. Brake does not come on when stop signal is applied. Tape does not stop on character, continued.	Brake magnet defective.	Check brake magnet and replace if defective as described in Section 5.6.4.
11. Light comes on but motor does not run.	Motor defective.	Check motor and replace if defective as described in Section 5.6.8.
12. Lamp does not come on, motor does not run, no d.c. voltages.	F1 blown.	Check F1 and replace if blown.
	Switch S1 defective.	Check switch S1 and replace if defective.
13. Irregular movement of tape and irregular frequency of outputs.	Pinch roller improperly adjusted.	Adjust drive magnet as described in Section 5.2.1.
	Brake not clean.	Clean brake magnet as described in Section 5.2.2.
	Capstan very badly worn.	Check condition of capstan and replace if badly worn as described in Section 5.6.6.
14. Irregular pulse width of outputs, frequency of outputs correct.	Drive belt tension improper.	Check the tension of the drive belt and adjust if necessary as described in Section 5.6.9. There should be no scraping of the top half of the belt with the bottom half.
	Front tape guide not up.	Raise front tape guide, after loading tape, to its upper stop as described in Section 3.3, step f.
	Tape in backward.	Make sure tape has been inserted as described in Section 3.3, step d.

Symptom	Probable Cause	Instructions
14. Irregular pulse width of outputs, frequency of outputs correct, continued.	Hole alignment in tape wrong.	Check the hole placement on tape to see that it conforms to standards.
15. Fuse F2 blows when drive signal is applied.	Rear tape guide improperly adjusted.	This may be true if the photocell readout assembly has been replaced. Check rear tape guide as described in steps q and r of Section 5.6.2 and readjust if necessary.
16. Proper lamp voltage cannot be obtained.	Transistor Q1 or Q2 defective.	Check Q1 or Q2 and replace if defective.
17. Brake does not release when RUN-LOAD switch is in the LOAD position.	Transistor Q4 or Z3 defective.	Check Q4 and/or Z3 and replace if defective. Recheck the lamp voltage as described in Section 5.2.4. Recheck the lamp focus and bias adjustment as described in Sections 5.2.3, 5.2.5 (or 5.2.6) and 5.2.7 (or 5.2.8).
18. Drive and brake magnets do not release when RUN-LOAD switch is in the LOAD position.	Diode D8 defective.	Check diode D8 and replace if defective.
19. +4 VDC rises to approximately +30 VDC, and -56 VDC rises to approximately -40 VDC, Lamp dim.	Switch S2 defective.	Check switch S2 and replace if defective.
	Diodes D6, D7 and/or D8 defective.	Check diodes D6, D7 and/or D8 and replace if defective.
	One or more of diodes D11-D15 defective.	Check diodes D11-D15 and replace any defective diode.



## SECTION 6

## PARTS LIST

Listed in this section are the various electronic and mechanical parts which are used in the reader. Indented items are part of the assembly under which they are indented and the quantity of these items are per each assembly. All items are available from REMEX Electronics, 5250 West El Segundo Boulevard, Hawthorne, California 90250. Reference designations refer to the parts illustrated in Section 7. All electronic components are identified by letter-number combinations in the Reference Designation column, and mechanical parts are identified by numbers only.

6.1 Electronic Parts List

<u>Description and Manufacturer's Part No.</u>	<u>REMEX Part No.</u>	<u>Quantity</u>	<u>Reference Designation</u>
Capacitor, Electrolytic, 5000 uf, 75 VDC Sprague 36D	702317-111	1	C1
Capacitor, Metalized Paper, 10 uf, 100VDC +10%, Electrocube 112A 1B106K	702191-106	2	C2,C3
Capacitor, Metalized Paper, 2 uf, 100 VDC +10% Electrocube 112A 1B205K	702191-205	2	C4,C5
Capacitor, Metalized Paper, .1 uf, 400 VDC +10% Electrocube 112A1E104K	702194-104	5	C6-C10
Capacitor, Metalized Paper, .33 uf, 100 VDC, +10% Electrocube 112A 1B334K	702191-334	1	C11
Capacitor, Paper-Oil, 5 uf, 330 VAC, +10% General Electric 49F2709FB	702453-505	1	GM
Capacitor, Metalized Paper, .47 uf, 400 VDC, +10%, Electrocube 112A1E474K	702194-474	1	C12
Connector, Electrical Plug, 19 Pin, Cannon RSK-19-22C-1/2	706500-119	1	P1
Connector, Electrical Plug, 19 Pin, Cannon RSK-19-22C-1/2W	706500-120	1	P2
Connector, Electrical Plug, Miniature, 15 Pin, Cannon DA-15S	706510-115	1	P3
Connector, Electrical Receptacle, 19 Pin, Cannon RSK-19-31SL	706510-117	1	J1
Connector, Electrical Receptacle, 19 Pin, Cannon RSK-19-31SL-W	706510-118	1	J2
Connector, Electrical Receptacle, 15 Pin, Cannon DA-15P	706500-117	1	J3
Diode, General Electric 1N1116A	704005-107	2	D1,D2
Diode, Sylvania 1N2069, RR-1002BA	704000-107	6	D3-D8
RR-10021A, RR-1002RA	704000-107	4	D4,D5,D7,D8
Diode, General Electric 1N3569	704005-109	5	D11-D15
Diode, Zener, 10 Volt, 10 watt, Motorola 1N2974B	704018-102	1	Z1
Diode, Zener, 30 Volts, 10 watt, Hoffman 1N1362	704018-108	1	Z2
Diode, Zener, 39 Volts, 10 watt, Motorola 1N2992	704018-109	1	Z3

6.1 Electronic Parts List, Cont:

<u>Description and Manufacturer's Part No.</u>	<u>REMEX Part No.</u>	<u>Quantity</u>	<u>Reference Designation</u>
Fuse, Slow Blow, Cartridge, 2 amp, Bussman MDL	705710-123	1	F1
Fuse, Extra Fast Blow, Cartridge, 2 amp, Bussman KAA	705720-118	1	F2
Fuse, Fast Blow, Cartridge, 1/2 amp, Bussman AGC	705715-114	1	F3
Fuseholder, Extractor Post Type, Littlefuse 342004	705750-100	2	(F1,F3)
Fuseholder, Watertight Extractor Post Type, Bussman HPC	705750-104	1	(F2)
Jack, Subminiature, Fixed Contact, Black, Raytheon TJ-405	715078-104	1	TP1
Jack, Subminiature, Fixed Contact, Red, Raytheon TJ-403R	715078-103	1	TP2
Jack, Subminiature, Fixed Contact, Yellow, Raytheon TJ-401Y	715078-106	1	TP3
Lamp, Incandescent, Double ended, 24 volt, 20 watt, REMEX Specification	715071-113	1	DS1
Module, Refer to Figure 1-3.			X1-X12
Motor, 115V, 1725 RPM, 1/50 HP, Bodine NSL-12	100745	1	M1
Relay, 6 VDC, 52 ohms, 4PDT Allied Control T154-4C	703500-107	1	K1
Resistor, Fixed, Carbon Composition, 150 ohm, 2 W, $\pm$ 5%, Allen-Bradley HB-5%, RR-1002BB	701006-151	3	R1-R3
RR-1002LB, RR-1002RB	701006-151	2	R2,R3
Resistor, Fixed, Wire-Wound, 75 ohm, 40 W, $\pm$ 5%, General Electric 1C9006A-40CA-75-EA701018-100		2	R4,R5
Resistor, Fixed, Wire-Wound, 350ohm, 10W, General Electric 1C9006A-10B-350-CA	701020-003	1	R6
Resistor, Fixed, Wire-Wound, 82 ohm, 5W, $\pm$ 5%, Ohmite 7/8-C-54-F	701016-820	1	R10
Resistor, Fixed, Carbon Composition, 100 ohm, $\frac{1}{2}$ W, $\pm$ 5%, Allen-Bradley EB-5%	701004-101	13	R19-R31
Resistor, Fixed, Carbon Composition, 33 ohm, 1 W, $\pm$ 5%, Allen-Bradley CB-5%	701005-330	1	R32
Resistor, Variable, Slide, Wirewound, 50 ohm, 25 W, General Electric 1C9006B- 25D-50-CA	701825-001	1	R7
Resistor, Variable, Rotating, Carbon Composition, 100 ohm, 2W, Allen- Bradley CLU	701520-101	1	R8
Resistor, Variable, Rotating, Carbon Composition, 25K, $\frac{1}{2}$ W, CTS 65LT	701505-253	1	R9
Resistor, Variable, Rotating, Wirewound, 20K, 1/2W, Bourns 3067-S	701660-203	8	R11-R18
Socket, Module, Amphenol 59-410	706515-110	10	(X1-X10)
Socket, Relay, Allied Control 30055-2	706515-111	1	(K1)
Switch, Toggle, DPDT, Arrow-Hart & Hegeman 83054	715055-117	2	S1,S2

## 6.1 Electronic Parts List, Cont:

<u>Description and Manufacturer's Part No.</u>	<u>REMUX Part No.</u>	<u>Quantity</u>	<u>Reference Designation</u>
Terminal Board, Ceramic, 11 Terminals Tektronix 124-091	715012-101	3	A,B,C
Terminal Board, Ceramic 9 Terminals, Tektronix 124-090	715012-103	3	D,E,F
Terminal Strip, Barrier, Panel Feed Thru, 7 Terminals, Cinch Jones 7-140Y	715010-108	2	TB1,TB2
Transformer, Regulating, 60 cycle, 95-130VAC Primary, 60VAC Secondary, Sola 21789	703000-112	1	T1
Transistor, Power, Germanium, PNP, Clevite CDT-1313, RR-1002BB	704210-106	4	Q1-Q4
	RR-1002LB, RR-1002RB	3	Q2-Q4

## 6.2 Mechanical Parts List

Bearing Holder Assembly, REMEX 102277, RR-1002BB	102277	2	1
RR-1002LB, RR-1002RB	102277	1	1
Bearing, Single Row, New Departure 77R6XR3E	714000-109	2	
Holder, Bearing, REMEX 100613	100613	1	
Retainer Ring, Truarc 5100-37	715025-103	2	
Shaft, REMEX 100614	100614	1	
Spacer Shim, REMEX 101928	101928	1	
Belt, REMEX 100746-11, RR-1002BB, <del>RR-1002RB</del>	100746-11	1	2
Belt, REMEX 100746-14, RR-1002LB	100746-14	1	2
Belt, Adjust Assembly, REMEX 101796	101796	1	3
Bracket, REMEX 101791	101791	1	
Wheel and Bearing Assembly, REMEX 101792	101792	1	
Bracket, Capacitor Cl, Sangamo DCM-10	715045-103	1	4
Bracket, REMEX 100821, RR-1002BB (CS)	100821	1	5
Bracket, REMEX 101119, RR-1002LB, RR-1002RB	101119	1	5
Brake Assembly, REMEX 101777, RR-1002BB	101777	2	6
RR-1002LB, RR-1002RB	101777	2	6
Brake Shoe, REMEX 101780	101780	1	
Brake Shoe Housing, REMEX 101781	101781	1	
Mounting Block Assembly, REMEX 102115	102115	1	
Spring, REMEX 101783	101783	1	
Capstan, REMEX 100612 RR-1002BB	100612	2	7
RR-1002LB, RR-1002RB	100612	1	7
Chassis, Electronic, REMEX 102178	102178	1	8
Cover, Electronic Chassis, REMEX 100874	100874	1	9
Cover, Lamp REMEX 102539	102539	1	10
Cover, Magnet, REMEX 102598	102598	1	11
Front Panel, RR-1002BB, REMEX 102614	102614	1	12
RR-1002LB, REMEX 102582	102582	1	12
RR-1002RB, REMEX 102581	102581	1	12

6.2 Mechanical Parts List Cont:

<u>Description and Manufacturer's Part No.</u>	<u>REMEM Part No.</u>	<u>Quantity</u>	<u>Reference Designation</u>
Grommet, Rubber, H.H. Smith 2174	715020-101	4	
Holder, Module, REMEX 100870	100870	1	13
Junction Shell, P3, Cannon DA-51211-1	716007-103	1	14
Lamp Bracket Assembly, REMEX 102530-1	102530-3	1	15
Bracket, REMEX 102543	102543	1	
Clip, Bussman 5960-09	705750-113	2	
Mounting Plate, REMEX 100696-2	100696-2	1	
Mounting Bracket, REMEX 100869	100869	2	16
PhotoCell Block Assembly, REMEX 102529-1	102529-1	1	17
Block, Tape Adjustor, REMEX 102699	102699	1	
Block, Upper, REMEX 102545	102545	2	
Lens, REMEX 100219	100219	1	
Mounting Block, REMEX 102535	102535	1	
Readout Assembly, REMEX 100588	100588	1	
Rear Tape Guide, REMEX 102544	102544	1	
Steel Ball, 3/32 Diameter	716014-101	1	
Spring, REMEX 100531	100531	1	
Tape Adjustor, REMEX 102389	102389	1	
Tape Clip, REMEX 100797	100797	1	
Tape Guide, REMEX 102390	102390	2	
Pinch Roller Drive Assembly, Left, RR-1002BB, RR-1002LB, REMEX 102601-2	102601-2	1	18
Magnet Assembly, REMEX 102602-2	102602-2	1	
Rocker Assembly, REMEX 102603	102603	1	
Bearing, Pivot Shaft, New Hampshire SR1563MMK15	714000-108	1	
Bearing, Pivot Shaft, New Hampshire SR1563MMEK15	714000-120	1	
Bearing, Pivot, Shaft, New Hampshire SR2-53MMK25	714000-117	2	
Block, REMEX 102607	102607	1	
Rocker Arm, REMEX 102608	102608	1	
Rollpin, Esna 79-012-062-0250	713810-002	1	
Shaft, Roller, REMEX 102605	102605	1	
Sleeve, Roller, REMEX 100615	100615	1	
Spacer, Roller, P.I.C. B4-19	715030-104	4	
Shaft, Pivot, REMEX 102606	102606	1	
Spring, REMEX 102903	102903	1	
Pinch Roller Drive Assembly, Right, RR-1002BB, RR-1002RB, REMEX 102601-1	102601-1	1	19
Subassemblies are the same as 102601-2 except:			
Magnet Assembly	102602-1	1	
Plate, Connector, REMEX 102179	102179	1	20
Pulley, REMEX 100611-4			
RR-1002BB	100611-4	2	21
RR-1002RB	100611-4	1	21
Pulley, REMEX 100611-5	100611-5	1	22
Tape Deflector, REMEX 101576	101576	2	23
Tape Roller Assembly, REMEX 102202	102202	2	24
Bearing, New Hampshire SR1563MMK15	714000-108	2	
Retainer Ring, Truarc 5100-18	715025-111	1	

6.2 Mechanical Parts List Cont:

<u>Description and Manufacturer's Part No.</u>	<u>REMUX Part No.</u>	<u>Quantity</u>	<u>Reference Designation</u>
Roller, REMEX 101837	101837	1	
Shaft, REMEX 101836	101836	1	
Trimpot Bracket Assembly, REMEX 101763	101763	1	25
Bracket, REMEX 101762	101762	1	
Rod, Threaded, REMEX 102693	102693	2	

6.3 Parts List, Ungated Option

Replace item 17 in Section 6.2 with the following:

PhotoCell Block Assembly, REMEX 102529-11	102529-11	1	17
Subassemblies are the same as 102529-1 except:			
Readout Assembly, REMEX 103611-1	103611-1	1	

## SECTION 7

### DRAWINGS AND PART LOCATION ILLUSTRATIONS

#### 7.1 Scope

Figures 7-1 through 7-13 contain the schematics and the photographs showing the part locations. All electronic components are identified by letter number combinations and correspond to the reference designations listed in Section 6.1. Mechanical parts are identified by numbers which refer to the reference designations in Section 6.2.

Some components in the reader are mounted on ceramic strips. Each strip has a letter designation. Refer to Figure 7-11. Because component designations are identified by letter-number combinations, terminal locations are differentiated by using letter-number combinations separated by a hyphen. Those items identified by a broken arrow indicate the location of parts obscured by other parts.

- 1 FOUR MODES 1, 2, 3, 4 OF 15 SIGNAL GND FOR MODES 3 & 4 OF 15 SIGNAL GND
- 2 FOR MODES 1, 2, 3, 4 OF 15 SIGNAL GND
- 3 FOR MODE 1, 2, 3, 4 OF 15 SIGNAL GND
- 4 ALL RESISTORS ARE 1/4 W, 25% TOLERANCE UNLESS OTHERWISE SPECIFIED.

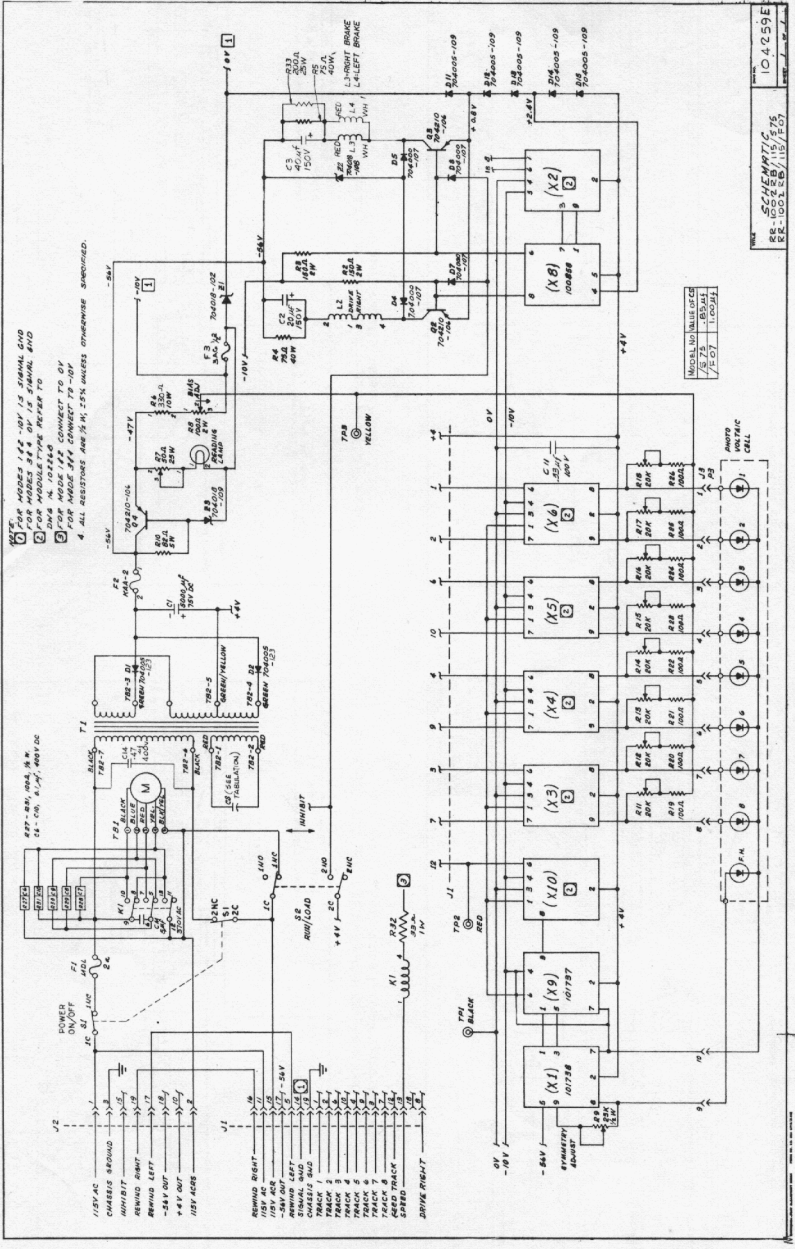

104259E  
 104259E  
 104259E  
 104259E

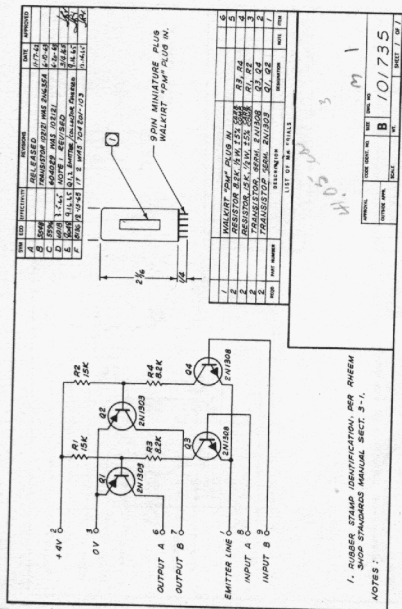

Figure 7-4. Track Output Amplifier Module (X3 to X6, X10) Schematic and Assembly, Modes 1 and 2.

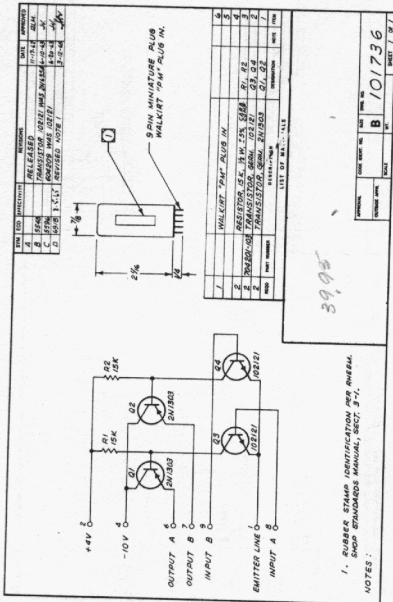

Figure 7-5. Track Output Amplifier Module (X3 to X6, X10) Schematic and Assembly, Modes 2 and 4.

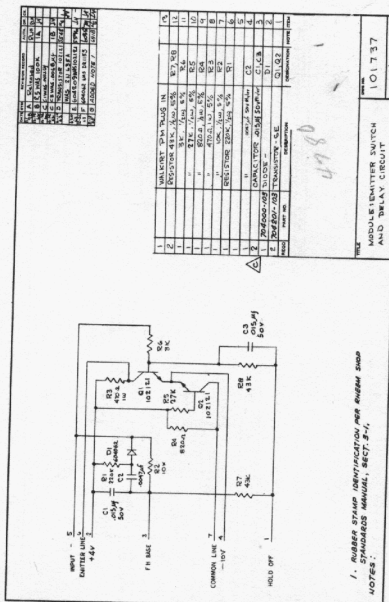

Figure 7-6. Emmitter Switch and Delay Module (X9), Schematic and Assembly, All Modes.

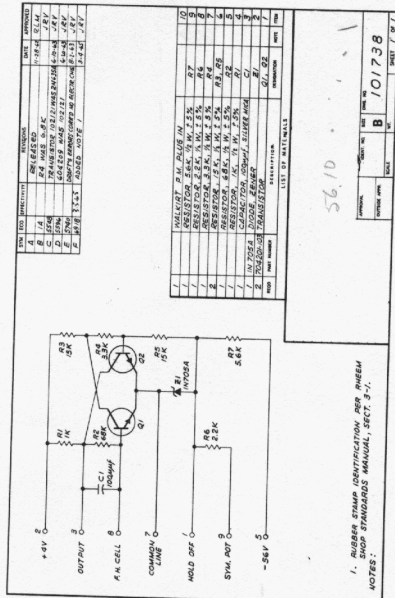

Figure 7-7. Schmitt Trigger Module (X1), Schematic and Assembly, All Modes.



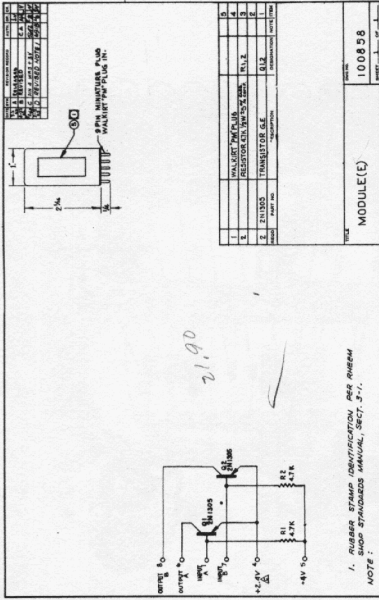

Figure 7-9. Drive and Brake Amplifier Module (X7, X8), Schematic and Assembly, All Models.

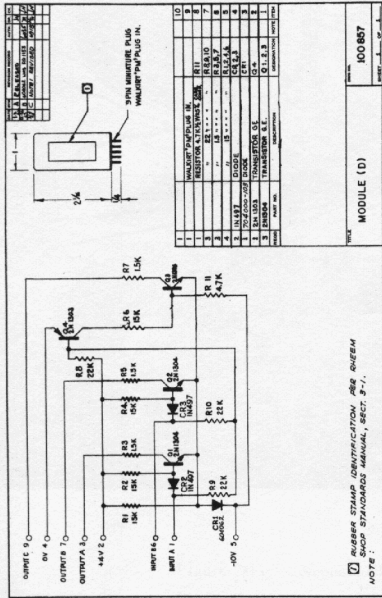

Figure 7-8. Input Control Module (X2), Schematic and Assembly, Modes 2 and 4.

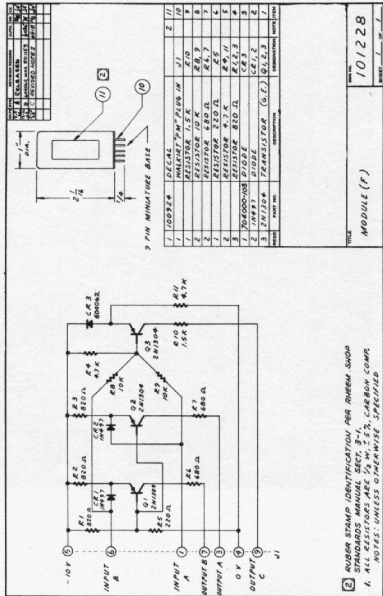

Figure 7-10. Input Control Module (X2), Schematic and Assembly, Modes 1 and 3.

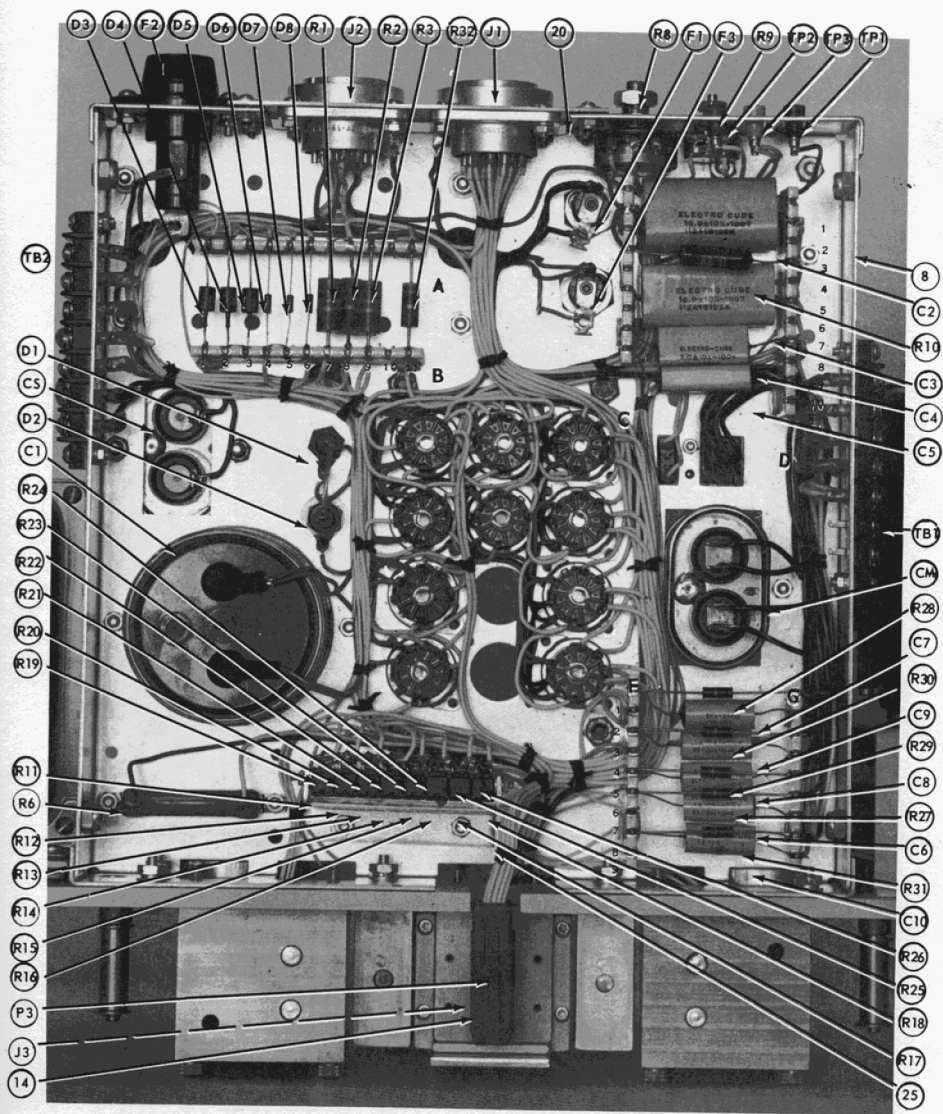

Figure 7-11. Component layout of the electronic chassis.

In Figure 7-11, for the RR-1002LB and RR-1002RB models only, the component arrangement for terminal boards F and G should be as shown below:

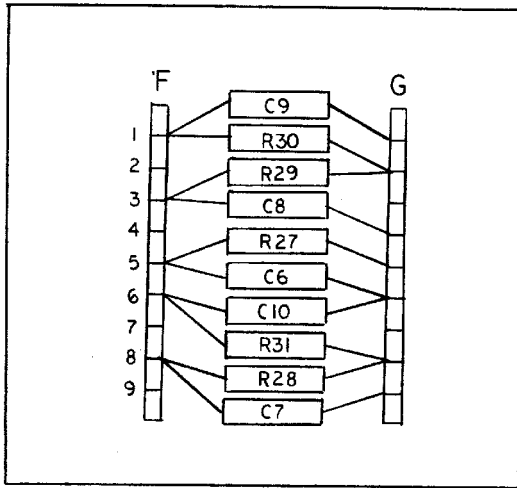

Figure 7-11A Component arrangement on terminals F and G for drive left and right only readers.



Figure 7-12. Component and mechanical layout of the top side of the chassis.

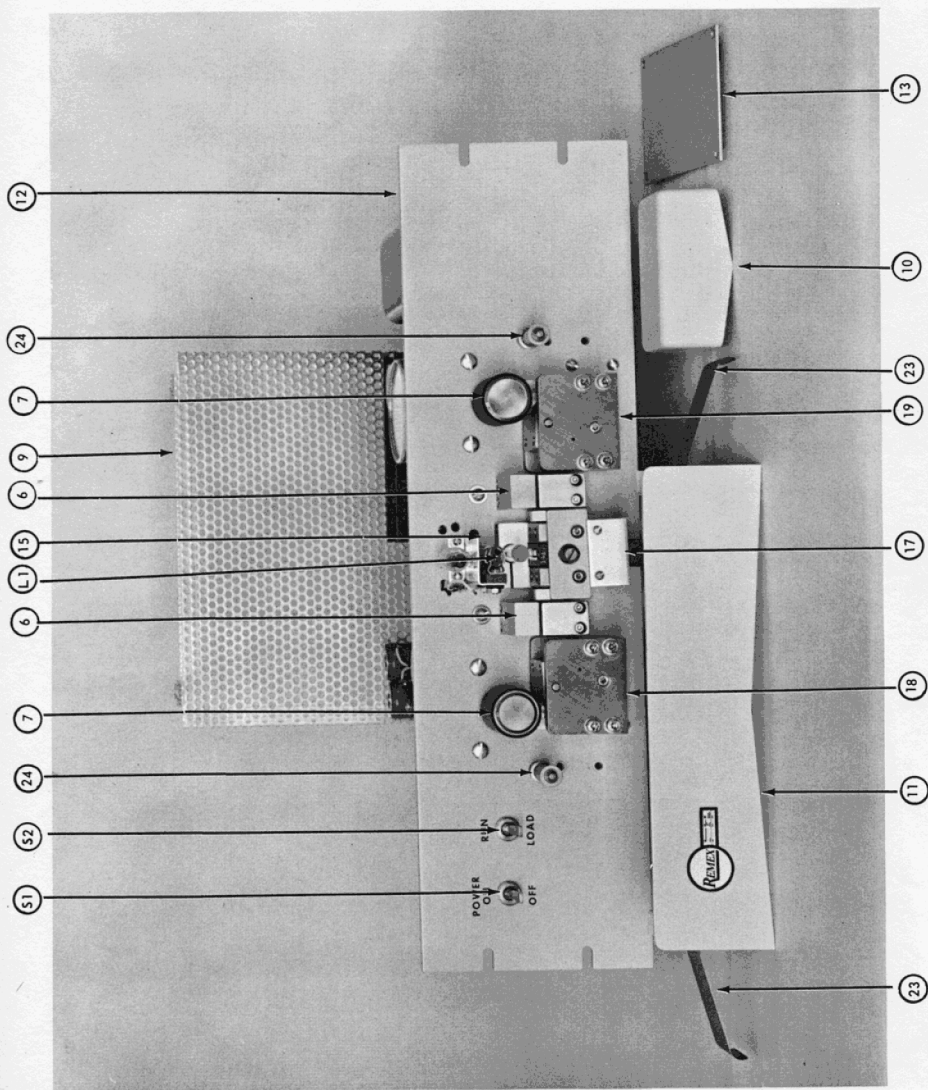

Figure 7-13. Front panel showing various mechanical and electronic parts.

### ADDENDUM SHEET

The following changes in the manual are required to make it applicable to the enclosed special reader:

1. A reduced copy of 104259 replaces pages 33, 34, and 35.
2. In Section 6.1, change C2 to 20 uf, 150 V, REMEX Part Number 702350-206.
3. In Section 6.1, change C3 to 40 uf, 150 V, REMEX Part Number 702350-406.
4. In Section 6.1, change reference designation C13 to C14.
5. In Section 6.1, add R33, 200 ohm, 1/4 W resistor, REMEX Part Number 701021-201.
6. In Section 6.1, change D1 and D2 to diode, 1N1614, REMEX Part Number 704005-123.